

solenoids & relays

H



STEEL & PHENOLIC BODY SOLENOIDS	H1
PVC COATED SOLENOIDS WITH STEEL HOUSINGS	H2
PLASTIC BODY SOLENOIDS	H3
ELECTRONIC SOLENOIDS	H4
RELAYS	H5
INFORMATION ON SOLENOIDS	H6

solenoids & relays

H1 STEEL & PHENOLIC BODY SOLENOIDS

Continuous Duty

85A except where noted. Normally Open Contacts, SPST, One circuit: Off - On Housings: Plated steel (Phenolic where noted). Contacts: Copper 5/16" -24 thread, hexnuts and lockwashers included. 200A solenoids have silver contacts. Coil, ignition and ground terminals: Steel 10-32 thread, hexnuts and lockwashers included. Bracket mounting holes 5/16" x 19/32" (7.9 x 15.1) on 2 13/64" centers (56.0mm).

48V insulated

See Section H3: 24848 heavy duty.

36V insulated

Available in Plastic Body (section H3): 24636, 24836 heavy duty.

24080

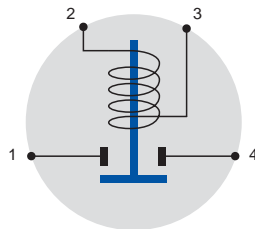

PVC coated model: see 24135

24080-01 UL-listed



Same as 24080, but UL and CE rated. Continuous Rating: 65A at 36V DC. Intermittent rating: 120A make, 65A break. 10 sec On, 30 min Off.

PVC coated model: see 24135-01

24V insulated

Also available in Plastic Body (section H3): 24624-10.

24063 ★

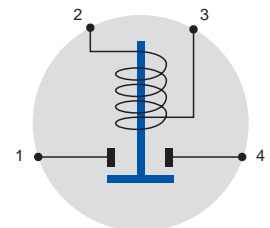

PVC coated and UL-rated model: see 24063-08

24107

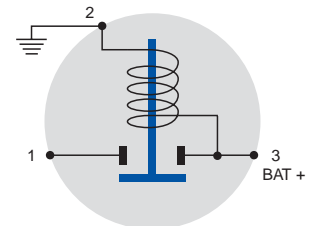

24144 200A ★

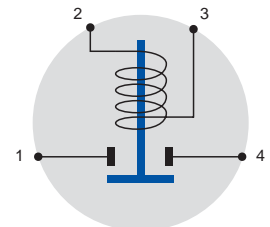

Electrical Rating: 200A carry only. Not to break 200A at 24V DC. Silver contacts.

CONTINUED **H1**

★ Rapid ship item. BP Available in retail clamshell pack. *Minimum order quantity may apply.

H solenoids & relays

H1 STEEL & PHENOLIC BODY SOLENOIDS

24V grounded

24124 ★

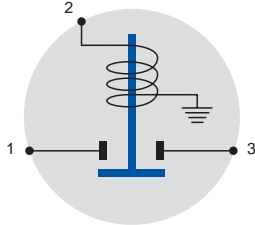

24420 Normally On

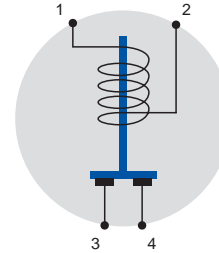

Continuous Duty 35A.

12V insulated

24115

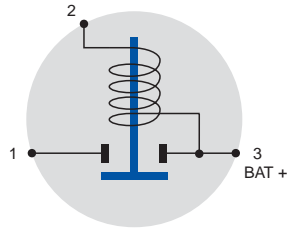

12V grounded

Also available in Plastic Body (section H3): 24612-G10.

24106 **BP** ★

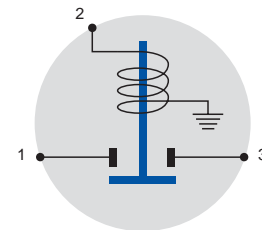

24059 **BP** ★

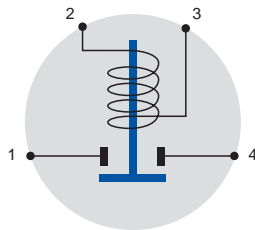

PVC coated model: see 24117

24082 curved bracket ★

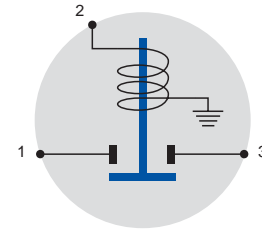

24059-08 UL listed **BP** ★



Same as 24059, but UL and CE rated.
Continuous Rating: 65A at 12V DC. Intermittent rating:
750A make, 100A break. 10 sec On, 30 min Off. Circuit G1.

PVC coated model: see 24117-01

6V

24097 insulated

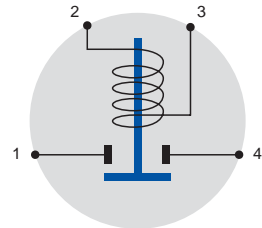

24143 200A ★

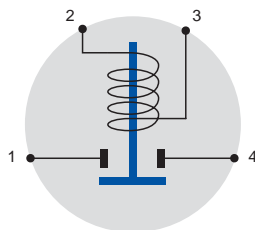

Electrical Rating: 200A. Silver contacts.

*24105 grounded

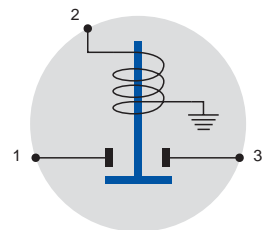

★ Rapid ship item. **BP** Available in retail clamshell pack. ★ Minimum order quantity may apply.

Two circuits, DPST

Normally Off and Normally On. Special application: for forward and reverse systems in electric golf carts, garden tractors, fork lift trucks, winches, etc. Housing: Steel. Continuous Duty, Normally Closed contacts 35A, Normally Open contacts 85A.

24400 36V insulated

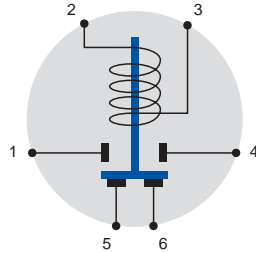

24402 24V insulated

Schematic and picture same as 24400.

24401 12V insulated ★

Schematic and picture same as 24400.

PVC coated model: see 24401-04.

24401-01 12V grounded ★

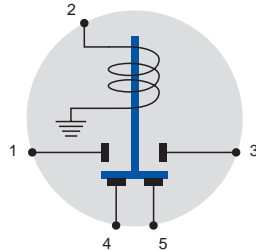

motor reversing

Typical DC series wound permanent magnet circuit, using a pair of double-action solenoids. Use pairs of the following solenoids: 24401 (12V), 24402 (24V), or 24400 (36V).

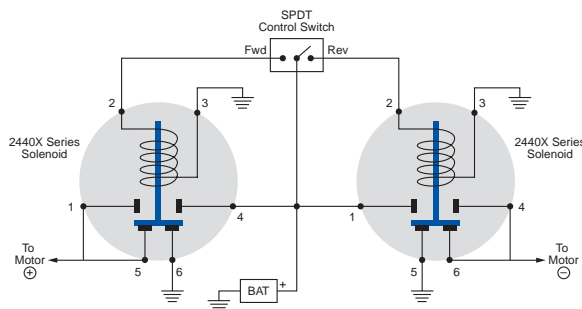

Latching Solenoid

12V Continuous Duty, 110A (carry only). Insulated. Plated steel housing. Requires only a momentary application of coil power to operate. Very little heat is generated, because the coil is de-energized when the solenoid is On.

24200

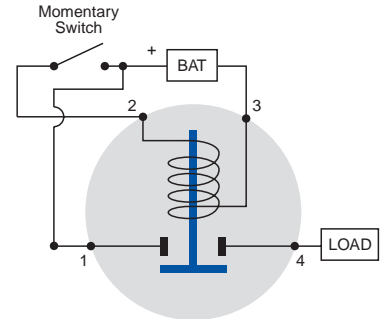

the latching solenoid

This special solenoid toggles On and Off, and requires no current to maintain the continuity of the power circuit. Use it with a momentary switch (see Momentary Switches). Actuation of the momentary switch causes current to flow in the solenoid coil, locking the contact in place, maintaining the load circuit in an On position. A second actuation of the momentary switch releases the plunger, turning the load circuit Off.

Suggested momentary switches: 55037, 58027-02.

Special Applications

Remote battery isolator

In a two-battery system, use the Latching Solenoid to isolate the batteries from each other, and prevent battery drain from the higher into the lower. It has an advantage over electronic Battery Isolators (see Battery-Related Products), in that it will not produce a voltage drop during operation.

Remote battery disconnect

Use it as a remote Battery Disconnect Switch. This eliminates the need for heavy gauge wiring between the control panel and the battery.

CONTINUED **H1**

★ Rapid ship item. BP Available in retail clamshell pack. ★ Minimum order quantity may apply.

H solenoids & relays

H1 STEEL & PHENOLIC BODY SOLENOIDS

Intermittent Duty

Normally Off, SPST, One circuit: Off - On
 750A make, 100A break, 10sec On, 20min Off, except where noted. Contacts: Copper. Terminals: Copper. Small ignition and ground terminals are 10-32 thread. Large contact terminals are 5/16" -24 thread. Hexnuts and lockwashers are included. Bracket mounting holes 5/16 x 19/32," 2 13/64" on centers (7.9 x 15.1, 56.0mm) and plated steel housing, except where noted.

24V insulated

120A make, 65A break. 10 sec On, 30 min Off.

24008 ★

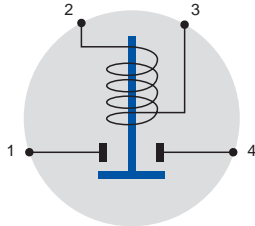

24044, angled bracket ★



24020 phenolic housing, curved bracket



24022 phenolic housing ★



Bracket mounting holes 9/32" x 25/64," 2 7/64" on centers (7.1 x 9.9, 53.6mm).

24104

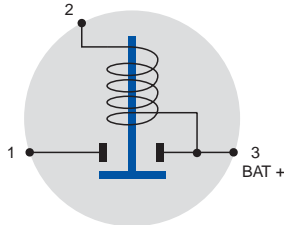

12V grounded, Resistor Shorting Circuit

In this application, 3 is Normally Open. It becomes common with 1 and 4 when the solenoid is energized. Commonly used in engine starting applications.

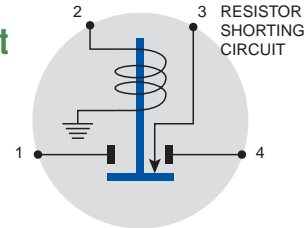

12V grounded

Also available in Plastic Body (section H3): 24712-GS7, 24612-G13.

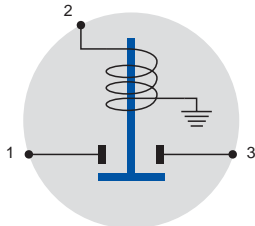

24103



24037 ★



PVC coated model: see 24071.

24021 phenolic housing ★



Bracket mounting holes 9/32 x 1/2," 2 13/64" on centers (7.2 x 12.7, 56.0mm). Contact terminal 5/16" -24 thread.

M-202 marine



Marine construction. Clear protective finish, brass hexnuts and lockwashers.

★ Rapid ship item. BP Available in retail clamshell pack. ★ Minimum order quantity may apply.

H1 STEEL & PHENOLIC BODY SOLENOIDS

24138 phenolic, with breather

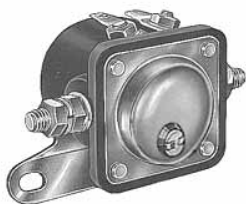

Bracket mounting holes 9/32 x 1/2," 2 13/64" on centers (7.2 x 12.7, 56.0mm). Contact terminal 5/16" -24 thread.

12V insulated

Also available in Plastic Body (section H3): 24512-03, 24512-13, 24612-13, 24712-S6, 24712-S7.

24047 ★

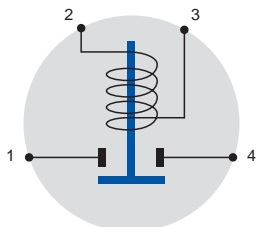

PVC coated model: 24076

M-200 marine BP

Same as 24047, but marine construction. Clear protective finish, brass hexnuts and lockwashers.

M-200-01 marine, UL listed



Same as M-200, but with UL & CE listing. Intermittent rating: 750A make, 100A break. 10 sec On, 30 min Off.

24060

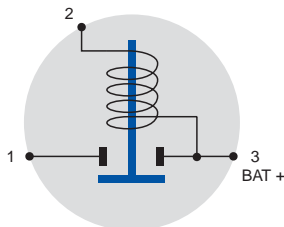

24046

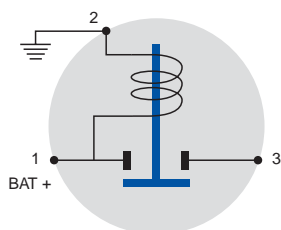

PVC coated model: 24077

24023 phenolic housing

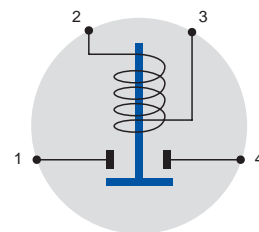

Bracket mounting holes 5/16" x 9/32," 2 9/16" on centers (8.1 x 7.2, 65.1mm).

2430 phenolic housing

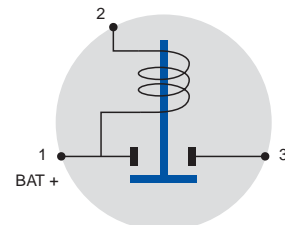

6V grounded

24041

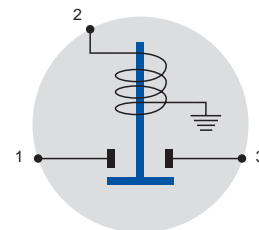

24039 curved bracket

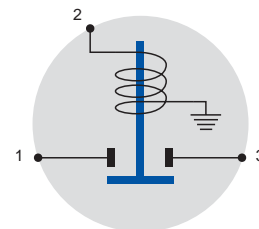

6V insulated

24043

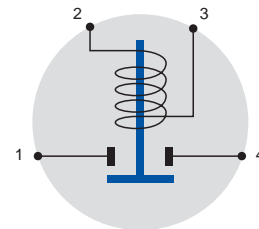

PVC COATED **H2**

★ Rapid ship item. BP Available in retail clamshell pack. ★ Minimum order quantity may apply.

H solenoids & relays

H2 PVC COATED SOLENOIDS WITH STEEL HOUSINGS

Weatherproof: Housing is completely PVC coated.

Continuous Duty

Insulated SPST, Normally Off (except 24401-04). One circuit: Off - On. Bracket mounting holes 5/16" x 19/32" (7.9 x 15.1) on 2 13/64" centers (56.0mm).

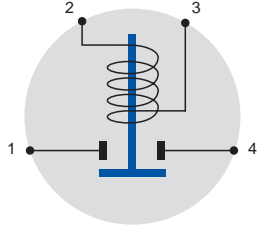

36V

24135

Continuous Duty: 85A.

Without PVC coating: see 24080

24135-01 UL listed



Continuous Duty: 65A at 36V DC

Intermittent Duty: 120A make, 65A break. 10 sec On, 30 min Off.

Without PVC coating: see 24080-01

24V

24063-08 UL listed ★



Continuous Duty: 65A at 24V DC

Intermittent Duty: 120A make, 65A break. 10 sec On, 30 min Off.

Without PVC coating and UL rating: see 24063

12V

24117 ★

Continuous Duty: 85A.

Without PVC coating: see 24059

24117-01 UL listed BP ★



Continuous Duty: 65A at 12V DC

Intermittent Duty: 750A make, 100A break. 10 sec On, 30 min Off.

Without PVC coating: see 24059-08

12V SPDT

24401-04

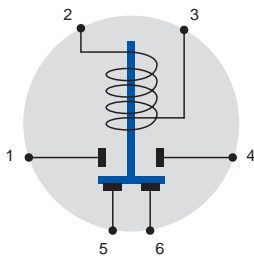

Normally Closed contacts 35A, Normally Open contacts 85A.

Without PVC coating: see 24401

★ Rapid ship item. BP Available in retail clamshell pack. ★ Minimum order quantity may apply.

Intermittent Duty

SPSAT, normally Off, 750A make, 100A break 750A make, 100A break. 10 sec On, 20 min Off. Bracket mounting holes 5/16 x 11," 2 13/64" on centers (7.9 x 15.1, 56.2mm). Contact terminals 5/16" -24 thread.

24076, insulated ★

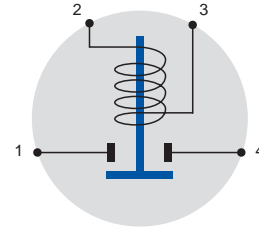

Without PVC coating: see 24047

24077, insulated

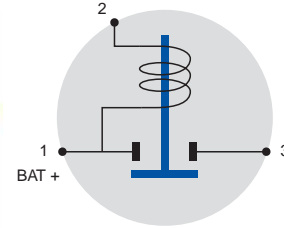

Without PVC coating: see 24076

24071, grounded

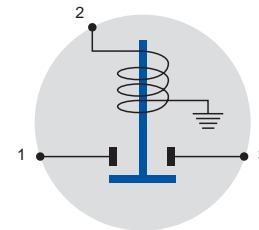

Without PVC coating: see 24037

solenoid info

See Section H6, and visit our website for an interactive training session on Solenoids.

H3 PLASTIC BODY SOLENOIDS

Glass-filled nylon construction - lightweight, durable and resistant to corrosion.

Continuous Duty, 100A

For starting small engines, including lawn tractors, golf carts and sweepers. SPST normally open contacts. 100A make and break, 400A inrush. Silver contacts. Large studs: 5/16"-24. 12V type: maximum operating voltage 14V DC. 24V type: maximum operating voltage 27V DC. 36V type: maximum operating voltage 36V DC. Cycle life: 50,000 minimum. Bracket mounting holes 5/16" x 19/32" (7.9 x 15.1) on 2 13/64" centers (56.0mm).

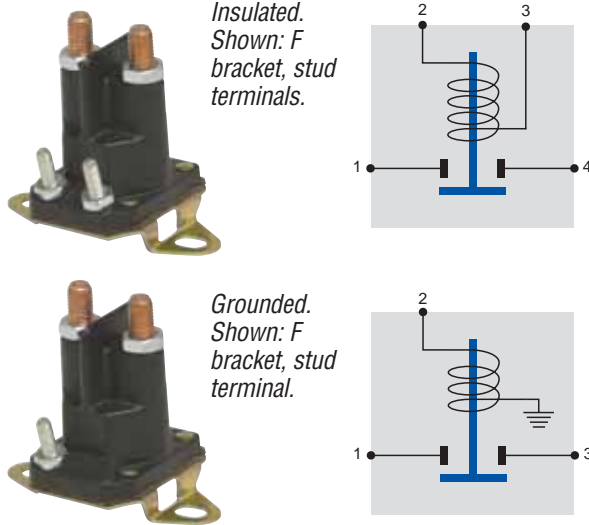

Intermittent Duty, 200A

For starting small engines, including lawn tractors, golf carts and sweepers. 12V DC. SPST normally open contacts. 200A make and break, 5 secs On, 5 secs Off, 300A inrush. (Sealed solenoids 200A make and break, 5 secs On, 5 secs Off. 500A inrush, maximum On time 20 secs.) Allow at least 40 secs cooling after maximum On time. Copper contacts. Maximum operating voltage 14V DC. Cycle life: 10,000 minimum. Sealed solenoids are protected against ingress of contaminants such as oil or gasoline, dirt and moisture. Bracket mounting holes 5/16" x 19/32" (7.9 x 15.1) on 2 13/64" centers (56.0mm).

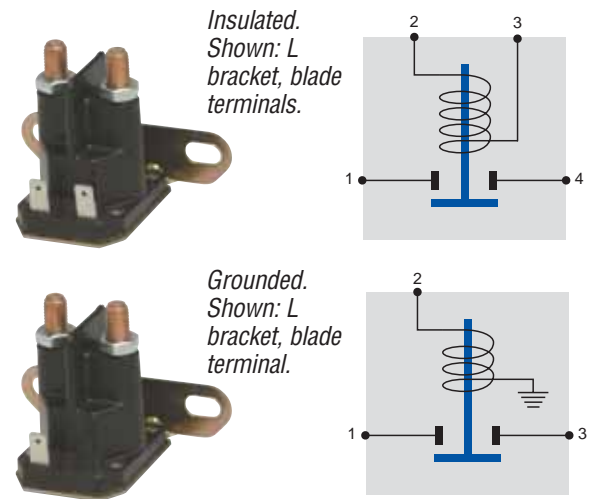

36V

24636 insulated
L bracket, two 10-32 stud coil terminals.

24V

24624-10 insulated
F bracket, two 10-32 stud coil terminals.

12V

24512-10 insulated BP
F bracket, two blade coil terminals.

24612 insulated
L bracket, two 10-32 stud coil terminals.

24612-10 insulated
F bracket, two 10-32 stud coil terminals.

24612-G10 grounded BP
F bracket, one 10-32 stud coil terminal.

Insulated 12V

24512-03 blade terminals, L bracket BP
5/16" -24 large studs, two blade coil terminals.

24512-13 blade terminals F bracket
5/16" -24 large studs, two blade coil terminals.

24612-03 stud terminals, L bracket BP
5/16" -24 large studs, two 10-32 stud coil terminals.

24612-13 stud terminals, F bracket
5/16" -24 large studs, two 10-32 stud coil terminals.

24712-S6 sealed, L bracket
1/4" -20 large studs, two 8-32 stud coil terminals.

24712-S7 sealed, F bracket
1/4" -20 large studs, two 8-32 stud coil terminals.

Grounded 12V

24612-G13 BP
5/16" -24 large studs, one 10-32 stud coil terminal.

24712-GS7 sealed BP
1/4" -20 large studs, one 8-32 stud coil terminal.

CONTINUED **H3**

★ Rapid ship item. BP Available in retail clamshell pack. ★ Minimum order quantity may apply.

Heavy Service, 225A

For use with heavy vehicles, materials handling, hydraulic systems, large DC machinery, and electric vehicles. SPDT normally open contacts. Insulated. 12-48V DC.

L bracket. Large studs: 5/16"-24, two 10-32 stud coil terminals. 12V silver contact, 50k cycles. Copper contact. Maximum operating voltage 14V DC, cycle life 25,000 minimum. 36V type: maximum operating voltage 36V DC, cycle life 50,000 minimum. 48V type: maximum operating voltage 48V DC. Cycle life: 50,000 minimum. Bracket mounting holes 5/16" x 19/32" (7.9 x 15.1) on 2 13/64" centers (56.0mm). Other types available by special order.

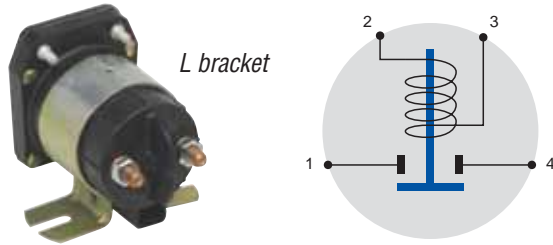

Continuous Duty

225A make and break, 600A inrush.

24848 48V
Silver contacts.

24836 36V
Silver contacts.

24824-01 24V
Silver contacts.

24812 12V
Copper contacts.

24812-01 12V
Silver contacts.

Intermittent Duty

600A inrush.

24824-04 24V
Copper contacts.

24812-04 12V
Copper contacts.

Motor Reversing Solenoid 12V

DPDT intermittent duty. 12V DC. Common ground coil. Two blade coil terminals, 5/16"-24 large studs. Copper contacts. F bracket. 75A make and break, maximum On time 5 mins. 125A make and break, maximum On time 30 secs. 150A make and break, maximum On time 0.5 secs. Allow 5 mins Off after max On time. Maximum operating voltage 14.5V DC. Cycle life 10,000 cycles at 5 secs On, 25 secs Off. Shipped with mounting hardware.

Use in conjunction with one of many types of Cole Hersee SPDT momentary switches: rocker (such as 58027-04), rotary (such as 72154-01/02) or ignition-type keyed switch (such as 75705-01).

Also available as 24V: 24450-02 with same rating as 24450. Contact Cole Hersee.

24450 BP

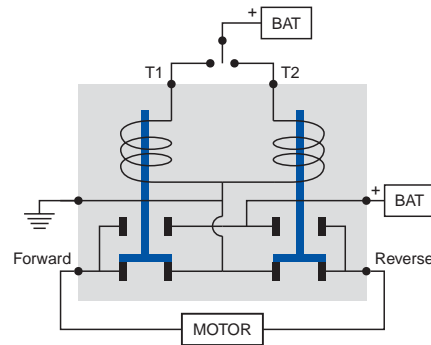

reversing solenoid

For reversing motors such as hoists, winches, windlasses, ATVs and snowplow blades. Two solenoids in one for cost and space savings and simpler wiring. Two integral solenoids provide dynamic braking for permanent magnet motors when neither coil is energized.

★ Rapid ship item. BP Available in retail clamshell pack. ★ Minimum order quantity may apply.

Electronic Solenoid

48785 Electronic Solenoid 85A 9-31V DC ★

Fully solid-state, with no moving parts to wear out. The Electronic Solenoid stands up to over 20 million On-Off cycles. It is completely sealed, ignition protected, and withstands vibration and adverse environments. Perfect for vehicles that are always on the move. Use the Electronic Solenoid in both 12V or 24V applications... or any voltage between 9 and 31V.

- Solenoid can be used in both High Side and Low Side switching applications.
- Needs only a very low control current.
- Suitable for high inrush demand circuits.



Specifications:

9 - 31V DC, 85A continuous or 175A intermittent.

Low On resistance of .005Ω

Low control current of .02A (max) means lighter wires, smaller harnesses.

On/Off control voltage must be identical to the system voltage.

Wide temperature operating range -40°C to + 85°C without derating.

Protected from transient voltage spikes or surges.

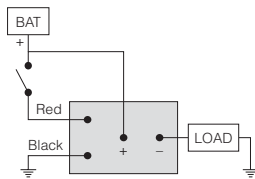

High side switching application

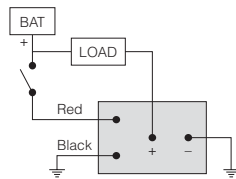

Low side switching application



emergency cutoff

Emergency cutoff switches are commonly mounted on many types of vehicles such as buses, and those used in construction and agriculture. Fire departments routinely familiarize themselves with the location of cutoffs, so that vehicles can quickly be isolated in case of emergency. Additionally, OSHA requires cutoffs on certain vehicles, particularly those with ancillary motorized equipment, such as garbage trucks. See Section J2.

Heavy Duty & High Power Relays

General purpose relays fit many vehicles. Typical applications include: lighting, starting, horn, heating and cooling. Standard ISO terminal footprint for Form A (SPST), Form C changeover (SPDT) and Form 2A (SPST, 2 terminals). Relays are available sealed and unsealed (unsealed are supplied with snap-in brackets.)

Specifications:

Pull-in voltage: 7.8V maximum at 12V DC, 15.6V at 24V DC.

Release voltage: 1.2V minimum at 12V DC, 2.4V at 24V DC.

Temperature range: -40°C to 85°C.

Operational life: Electrical to 100,000 cycles; Mechanical to 10 million cycles.

Contact Material: Silver alloy.

Dielectric strength: 500V rms between coil and contact.

Insulation resistance: 100M Ω minimum (500V DC).

Vibration resistance: 10-40Hz double amplitude 1.5mm.

Cole Hersee Relays are rated based on a steady state resistive load. De-rate according to the type of load: Motor load: Inrush can be 5 to 10 x steady state current. Solenoid load: Inrush can be 10 to 20 x steady state current. Incandescent lamp load: Inrush can be 10 to 15 x steady state current.

Relays are also available with PC terminals. Contact Cole Hersee.

Heavy Duty Relays 40A at 12V DC



Specifications:

Contact rating (Resistive load) at 20°C:

12V DC: Normally Open 40A, Normally Closed 30A.

24V DC: Normally Open 20A, Normally Closed 15A.

Contact arrangement: Available as Form A (SPST), Form C (SPDT) and Form 2A (SPST, 2 terminals).

High Power Relays 70A at 12V DC



Specifications:

Contact rating (Resistive load) at 20°C:

12V DC: Normally Open 70A, Normally Closed 60A.

24V DC: Normally Open 35A, Normally Closed 30A.

Contact arrangement: Available as Form A (SPST) and Form C (SPDT).

Relay Schematics & Terminal Layouts

Other configurations are available by special order.

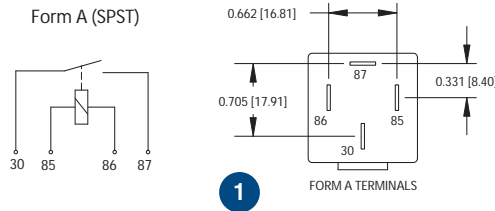

40A Type has .250" terminals. 70A Type has .375" terminals.

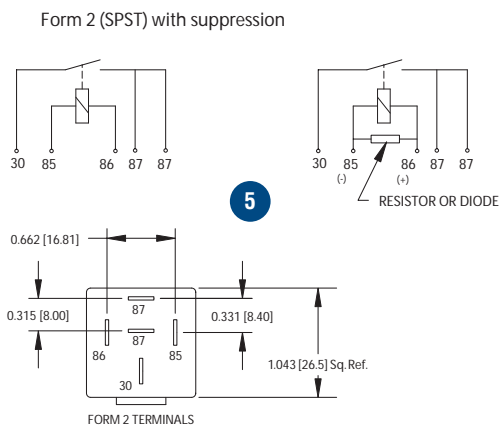
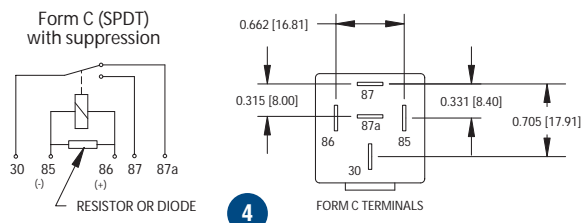
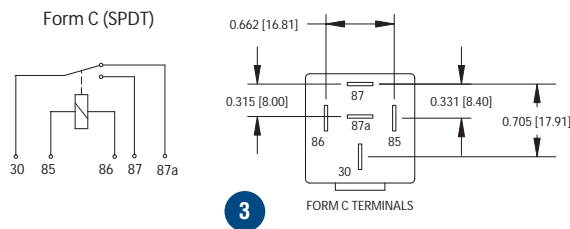
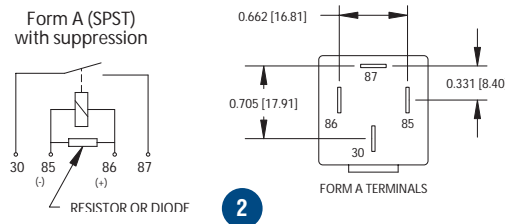

Relay Part Number Structure

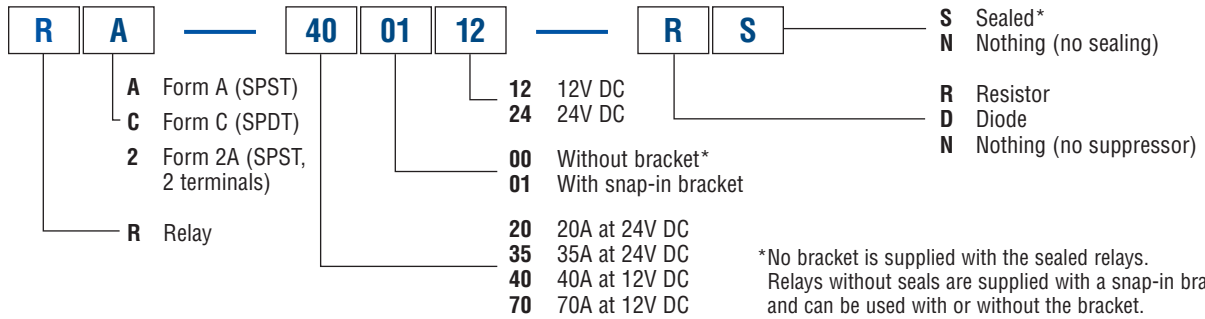

Relay Stock Items

Other configurations, and PC terminals are available. Contact Cole Hersee.

FORM	AMPERAGE	BRACKET	VOLTAGE	SUPPRESSOR	SEAL	PART NUMBER	DIAGRAM
A: SPST	40	01 Snap-in	12	N: none	N: no seal	RA-400112-NN BP	1
A: SPST	40	01 Snap-in	12	R: resistor	N: no seal	RA-400112-RN BP	2
A: SPST	40	01 Snap-in	12	D: diode	N: no seal	RA-400112-DN BP	2
A: SPST	20	01 Snap-in	24	N: none	N: no seal	RA-200124-NN BP	1
A: SPST	20	01 Snap-in	24	R: resistor	N: no seal	RA-200124-RN BP	2
A: SPST	20	01 Snap-in	24	D: diode	N: no seal	RA-200124-DN BP	2
A: SPST	40	00 None	12	D: diode	S: sealed	RA-400012-DS BP	2
A: SPST	20	00 None	24	D: diode	S: sealed	RA-200024-DS BP	2
C: SPDT	40	01 Snap-in	12	N: none	N: no seal	RC-400112-NN BP	3
C: SPDT	40	01 Snap-in	12	R: resistor	N: no seal	RC-400112-RN BP	4
C: SPDT	40	01 Snap-in	12	D: diode	N: no seal	RC-400112-DN BP	4
C: SPDT	20	01 Snap-in	24	N: none	N: no seal	RC-200124-NN BP	3
C: SPDT	20	01 Snap-in	24	R: resistor	N: no seal	RC-200124-RN BP	4
C: SPDT	20	01 Snap-in	24	D: diode	N: no seal	RC-200124-DN BP	4
C: SPDT	40	00 None	12	D: diode	S: sealed	RC-400012-DS BP	4
C: SPDT	20	00 None	24	D: diode	S: sealed	RC-200024-DS BP	4
2: SPST	20	01 Snap-in	24	R: resistor	N: no seal	R2-200124-RN	5
2: SPST	40	01 Snap-in	12	R: resistor	N: no seal	R2-400112-RN	5
A: SPST	70	01 Snap-in	12	N: none	N: no seal	RA-700112-NN BP	1
A: SPST	70	01 Snap-in	12	R: resistor	N: no seal	RA-700112-RN BP	2
A: SPST	70	01 Snap-in	12	D: diode	N: no seal	RA-700112-DN BP	2
C: SPDT	70	01 Snap-in	12	N: none	N: no seal	RC-700112-NN BP	3
C: SPDT	70	01 Snap-in	12	R: resistor	N: no seal	RC-700112-RN BP	4
C: SPDT	70	01 Snap-in	12	D: diode	N: no seal	RC-700112-DN BP	4

CONTINUED **H5**

★ Rapid ship item. BP Available in retail clamshell pack. ★ Minimum order quantity may apply.

MicroRelays 25A at 12V DC

MicroRelays fit many vehicles and applications. They have a reduced size, but can accept a 25A load. Typical applications include: lamp control, horns, power windows, fuel pumps, fans and lifts gates. Standard terminal footprint for Form A (SPST), Form C changeover (SPDT) MicroRelays are available sealed and unsealed.



Specifications:

Contact rating (Resistive load) at 20°C:

12V DC: Normally Open 25A, Normally Closed 20A.

24V DC: Normally Open 15A, Normally Closed 10A.

Contact arrangement: Available as Form A (SPST), and Form C (SPDT).

Vibration resistance: 10-40Hz double amplitude 1.27mm.

Pull-in voltage: 7.8V maximum at 12V DC, 15.6V at 24V DC.

Release voltage: 1.2V minimum at 12V DC, 2.4V at 24V DC.

Temperature range: -40°C to 85°C.

Operational life: Electrical to 100,000 cycles. Mechanical to 10 million cycles.

Contact Material: Silver alloy.

Dielectric strength: 500V rms between coil and contact.

Insulation resistance: 100MΩ minimum (500V DC).

Cole Hersee Relays are rated based on a steady state resistive load. De-rate according to the type of load:

Motor load: Inrush can be 5 to 10 x steady state current.

Solenoid load: Inrush can be 10 to 20 x steady state current.

Incandescent lamp load: Inrush can be 10 to 15 x steady state current.

MicroRelays are also available with PCB terminals: contact Cole Hersee.

MicroRelay Schematics & Terminal Layouts

Other configurations are available by special order.

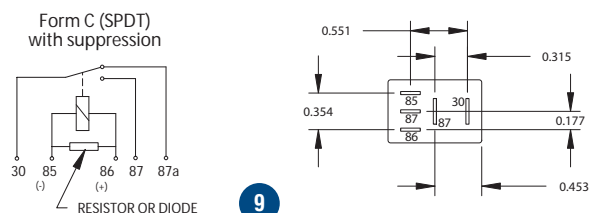
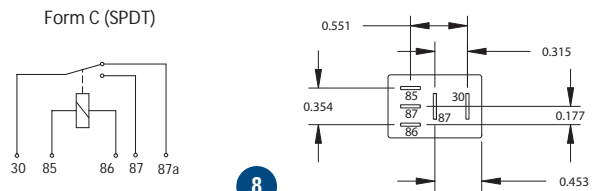
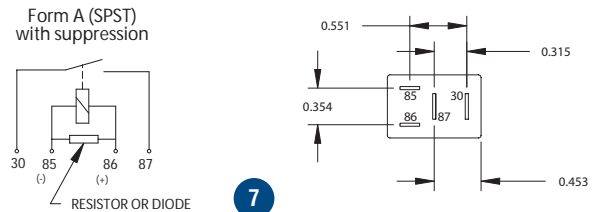
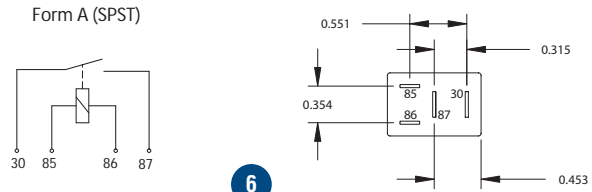

MicroRelay Part Number Structure

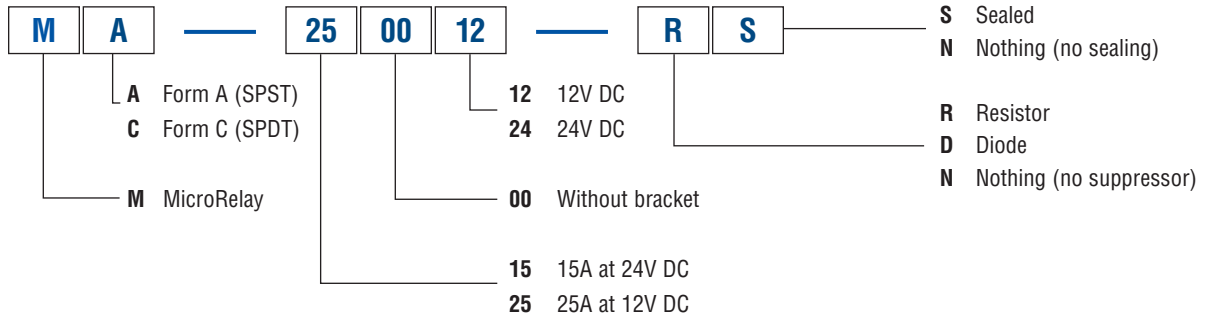

MicroRelay Stock Items

Other configurations, and PC terminals are available. Contact Cole Hersee.

FORM	AMPERAGE	VOLTAGE	SUPPRESSOR	SEAL	PART NUMBER	DIAGRAM
A: SPST	25	12	R: resistor	N: no seal	MA-250012-RN	7
A: SPST	25	12	R: resistor	S: sealed	MA-250012-RS	7
A: SPST	25	12	D: diode	N: no seal	MA-250012-DN	7
A: SPST	25	12	N: none	N: no seal	MA-250012-NN	7
A: SPST	15	24	R: resistor	N: no seal	MA-150024-RN	7
A: SPST	15	24	R: resistor	S: sealed	MA-150024-RS	7
A: SPST	15	24	D: diode	N: no seal	MA-150024-DN	7
A: SPST	15	24	N: none	N: no seal	MA-150024-NN	6
C: SPDT	25	12	R: resistor	N: no seal	MC-250012-RN	9
C: SPDT	25	12	R: resistor	S: sealed	MC-250012-RS	9
C: SPDT	25	12	D: diode	N: no seal	MC-250012-DN	9
C: SPDT	25	12	N: none	N: no seal	MC-250012-NN	8
C: SPDT	15	24	R: resistor	N: no seal	MC-150024-RN	9
C: SPDT	15	24	R: resistor	S: sealed	MC-150024-RS	9
C: SPDT	15	24	D: diode	N: no seal	MC-150024-DN	9
C: SPDT	15	24	N: none	N: no seal	MC-150024-NN	8

CONTINUED **H5**

H solenoids & relays

H5 RELAYS

Relay Sockets

Accepts Cole Hersee relays and standard ISO relays. Modular – sockets dovetail together. Accepts standard quick-connect terminals. Easy mount bracket. Constructed of rugged glass-filled polyamide. Temperature range -40F to 85C.

99025 High Power Socket



For use with Cole Hersee High Power Relays. Form A (SPST)
Use with Tyco (AMP) terminals 280756 or 280755 (consult terminal manufacturers for full specs).

99026 Heavy Duty Socket



For use with Cole Hersee Heavy Duty Relays. Form A (SPST) or Form C (SPDT).
Use with Tyco (AMP) terminals 42281 or Ark-Les 3000H112A series (consult terminal manufacturers for full specs).

solenoids & relays

H6 INFORMATION ON SOLENOIDS

Solenoids are relays which are commonly used to remotely switch a heavier current. By using a solenoid, the amount of heavy wiring needed to power the load is reduced, since the control circuit mounted inside the cab typically utilizes a smaller wire gauge.

Solenoids are commonly used to control starter and winch motors, and they have many other uses on vehicles of all kinds.

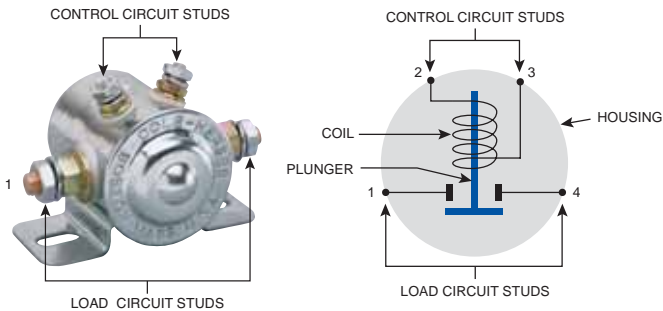

A typical 4-stud solenoid

4-stud solenoid diagram

The diagram shows a magnetic coil surrounding a contact plunger. Before energization, the plunger is not electrically connected to the control circuit. When the control circuit is energized, the electromagnetic force induced in the coil attracts the plunger, which moves to close the load circuit. When the control circuit is de-energized, the spring-loaded plunger returns to its normal state and the load circuit is broken. In continuous duty applications, energization of the coil causes heating, therefore the solenoid housing will become warm even in normal operation.

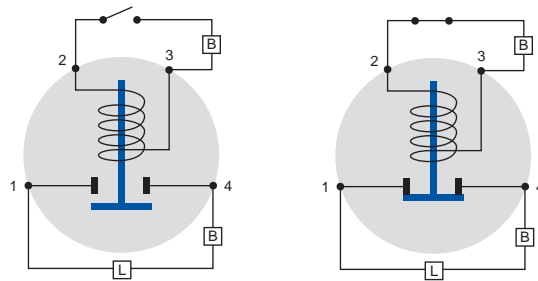

Solenoid in its normal state
Control circuit and load circuit open

Energized solenoid
Control circuit and load circuit closed

For more information on solenoids, visit the interactive training section of the Cole Hersee website:
www.colehersee.com > Resource Center > Training.

★ Rapid ship item. BP Available in retail clamshell pack. ★ Minimum order quantity may apply.